



Technické parametry:

Maximální pracovní tlak: 10 barů

Maximální pracovní teplota: 100°C

Technical features

Max working pressure: 10 Bar

Max temperature: 100°C

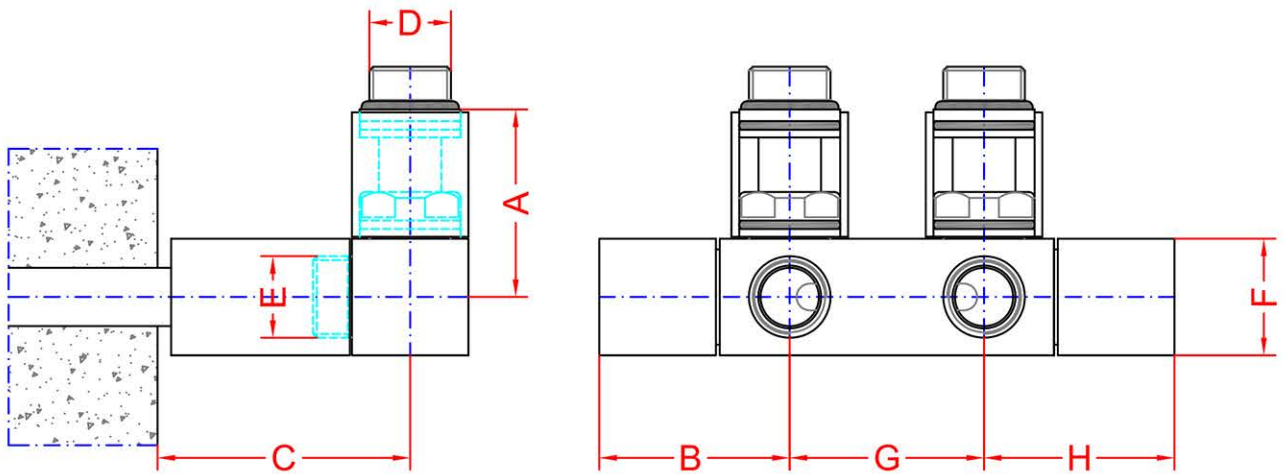

D	A	B	C	E	F	G	H
1/2"	48	51	65	1/2"	30	50	51

CP582