

# INSTALLATION INSTRUCTION

## TWO HANDLES WASHBASIN MIXER

### ※ACCESSORIES CHECKING

#### LIST OF THE STANDARD ACCESSORIES:

Please double-check the accessory list hereinafter and contact our company or our distributor for any unconformity.

Remarks:

1. Without affecting their performing, accessories may be changed without further notice;
2. Drawings for reference only, Product size & shape refer to actual faucet.

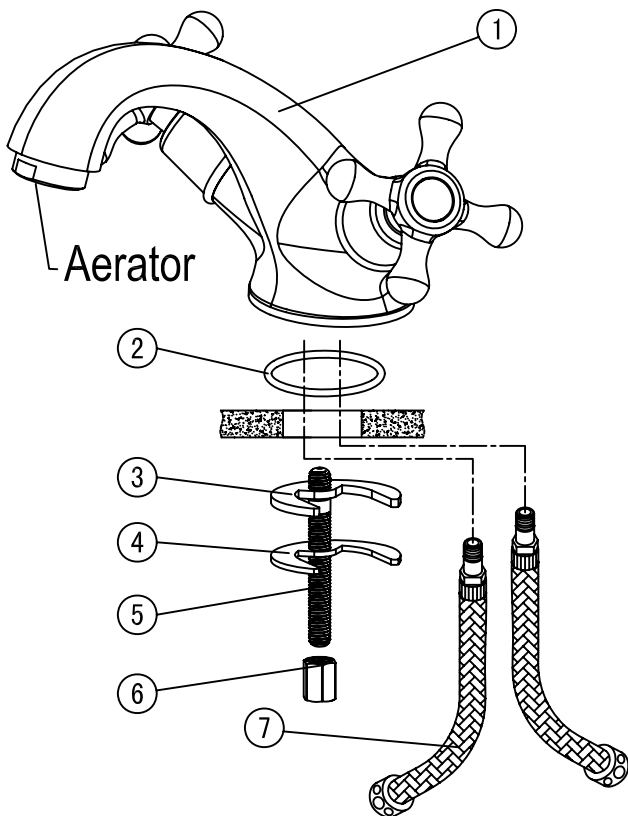

Code	The Accessory List	Quantity
1	Main body	1
2	O-ring	1
3	Cushing	1
4	Gasket	1
5	Fixing bolt	1
6	Nut	1
7	Inlet pipe	2

### ※Installation Instructions

- ☆ Do not disassemble the main body, as it has been installed & commissioned correctly & precisely before leaving the factory;
- ☆ To avoid the faucet from jamming, do flush the water pipe before installation;
- ☆ After installation, make sure every joint safely sealed & no leaking;
- ☆ Using condition: Working pressure at 0.05-1.0MPa (including cold & hot water pressure), with applicable water temperature: 4°C-90°C;
- ☆ Make sure to connect the hot/cold inlet pipe correctly, if standing in front, hot water pipe connecting to the left & cold water pipe connecting to the right.

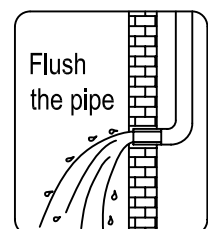
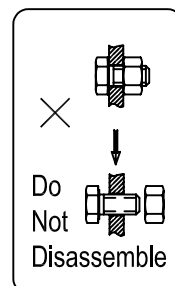

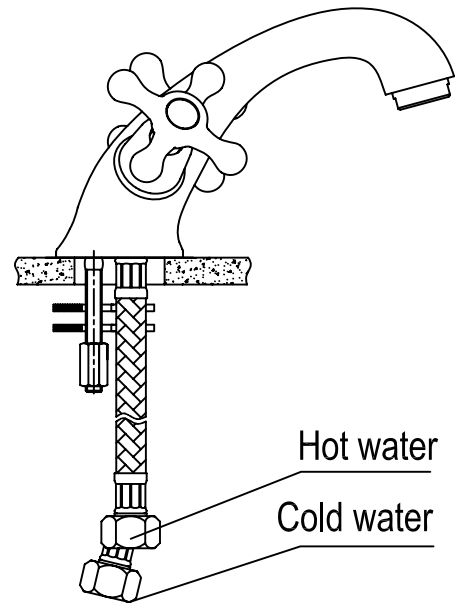
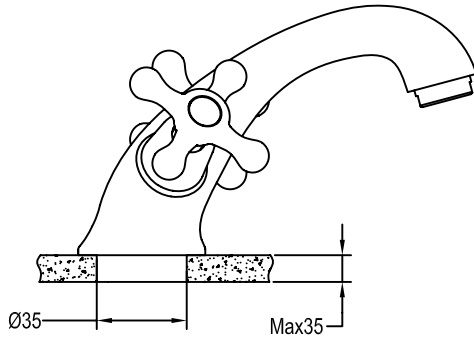

### ※Installation Procedures

- ☆ Make sure the installation holes to be in right size;
- ☆ Connect the main body & water supply pipe with water inlet pipe.

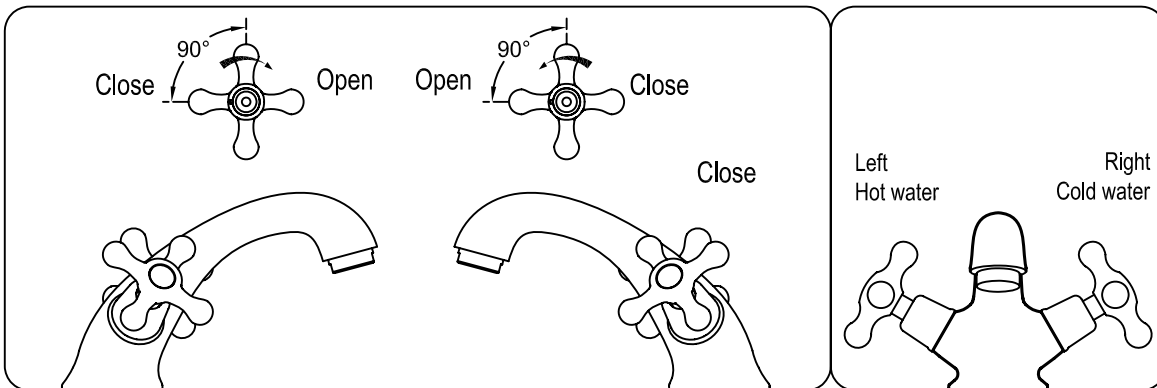

### ※Usage

☆How to operate the handwheel

- 1.The left handwheel: To turn on the hot water directly,The largest rang is 90°,and turn off rightabout.
- 2.The right handwheel: T to turn on the cold water rightabout and turn off directly.

### ※Cleaning & Maintenance

☆ To keep the product clean & shining, follow the as below:

- 1.Flush with clean water & dry with soft cloth only;
- 2.If any dirt, clean with soft liquid or transparent glass detergent;
- 3.Do not use any scrubbing detergent, polisher, sane-cloth, paper tissue or scraper;
- 4.Do not use acid detergent, indissolvable grain-like detergent or soap;
- 5.Circumrotate the aerator off and clean it when necessary.

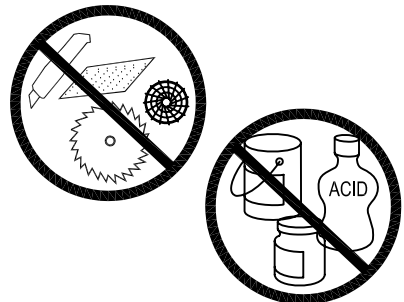

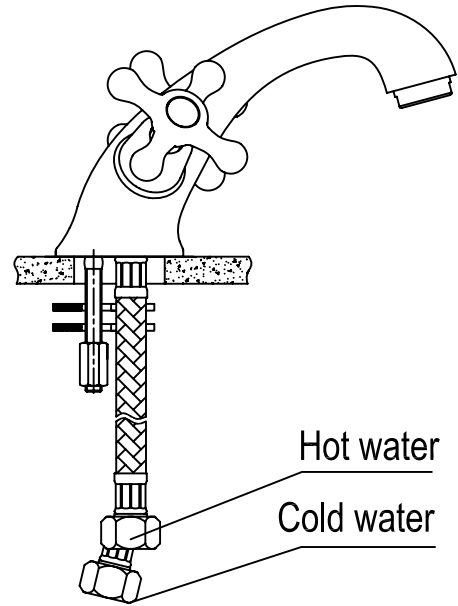
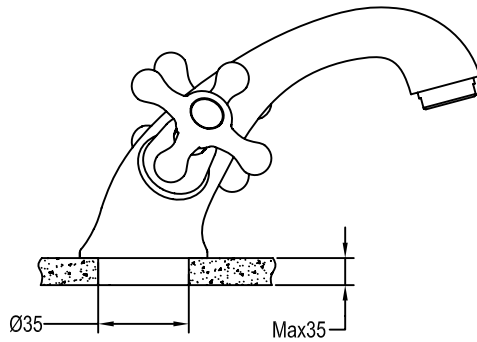

## ※Installation Procedures

- ☆ Make sure the installation holes to be in right size;
- ☆ Connect the main body & water supply pipe with water inlet pipe.

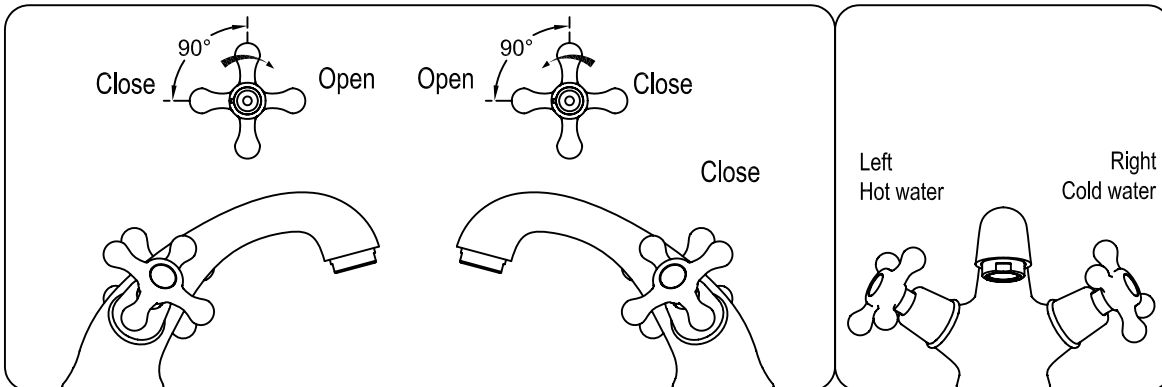

## ※Usage

☆How to operate the handwheel

- 1.The left handwheel: To turn on the hot water directly,The largest rang is 90°,and turn off rightabout.
- 2.The right handwheel: Toturn on the cold water rightabout and turn off directly.

## ※Cleaning & Maintenance

☆ To keep the product clean & shining, follow the as below:

- 1.Flush with clean water & dry with soft cloth only;
- 2.If any dirt, clean with soft liquid or transparent glass detergent;
- 3.Do not use any scrubbing detergent, polisher, sane-cloth, paper tissue or scraper;
- 4.Do not use acid detergent, indissolvable grain-like detergent or soap;
- 5.Circumrotate the aerator off and clean it when necessary.

