

# VÝTOKOVÁ HUBICE BOCCA BORDO VASCA BATH SPOUT 5106

POŘADÍ DÍLŮ PŘI MONTÁŽI  
DISPOSIZIONE COMPONENTI PER  
INSTALLAZIONE BOCCA  
DISPOSITION COMPONENTS

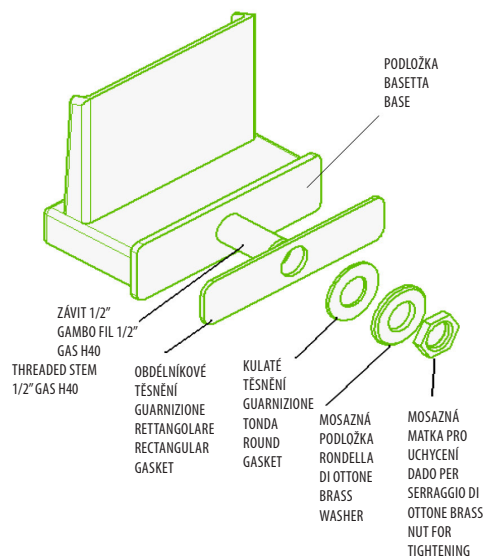
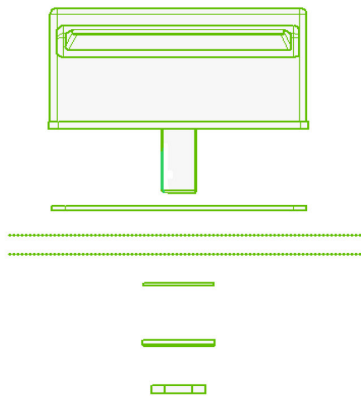

délka hubice do prostoru sporgenza PROTRUSION	102 mm
rozměr podložky dimensioni basetta BASE SIZE	168 x 45 mm
výška hubice od podložky altezza bocca dalla base SPOUT HEIGHT FROM BASE	53 mm

průtok  
portata  
FLOW RATE

tlak pressione bar pressure	l/min litri/min liters/min
1	15
1,5	17
2	19
3	24
4	27

