

INSTALLATION MANUAL

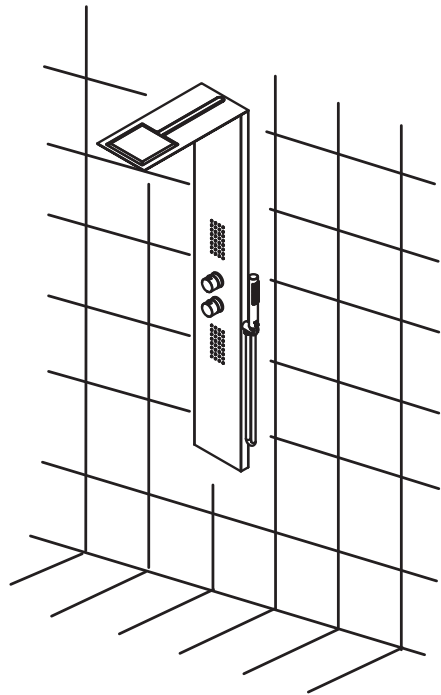
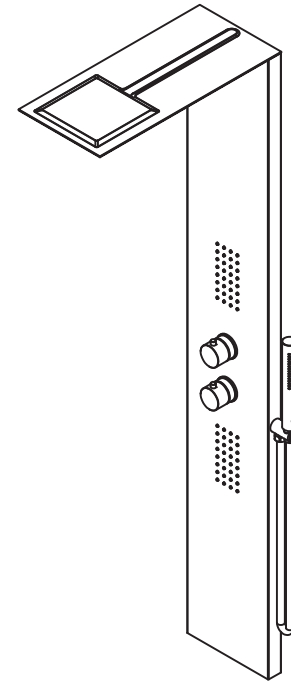

Chart8

Hang the shower panel on the mounting brackets securely on the wall.

Pověste sprchový panel na držáky bezpečně na zed'



01 / PRODUCT

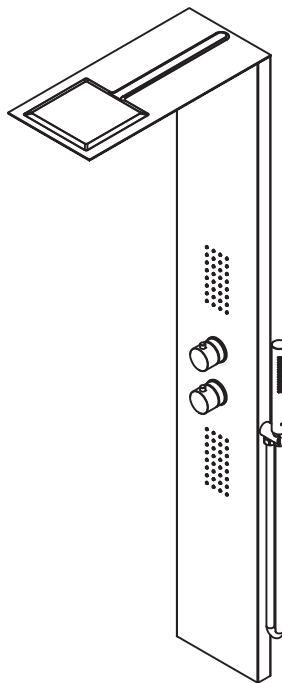

02 / TOOLS NOT INCLUDED

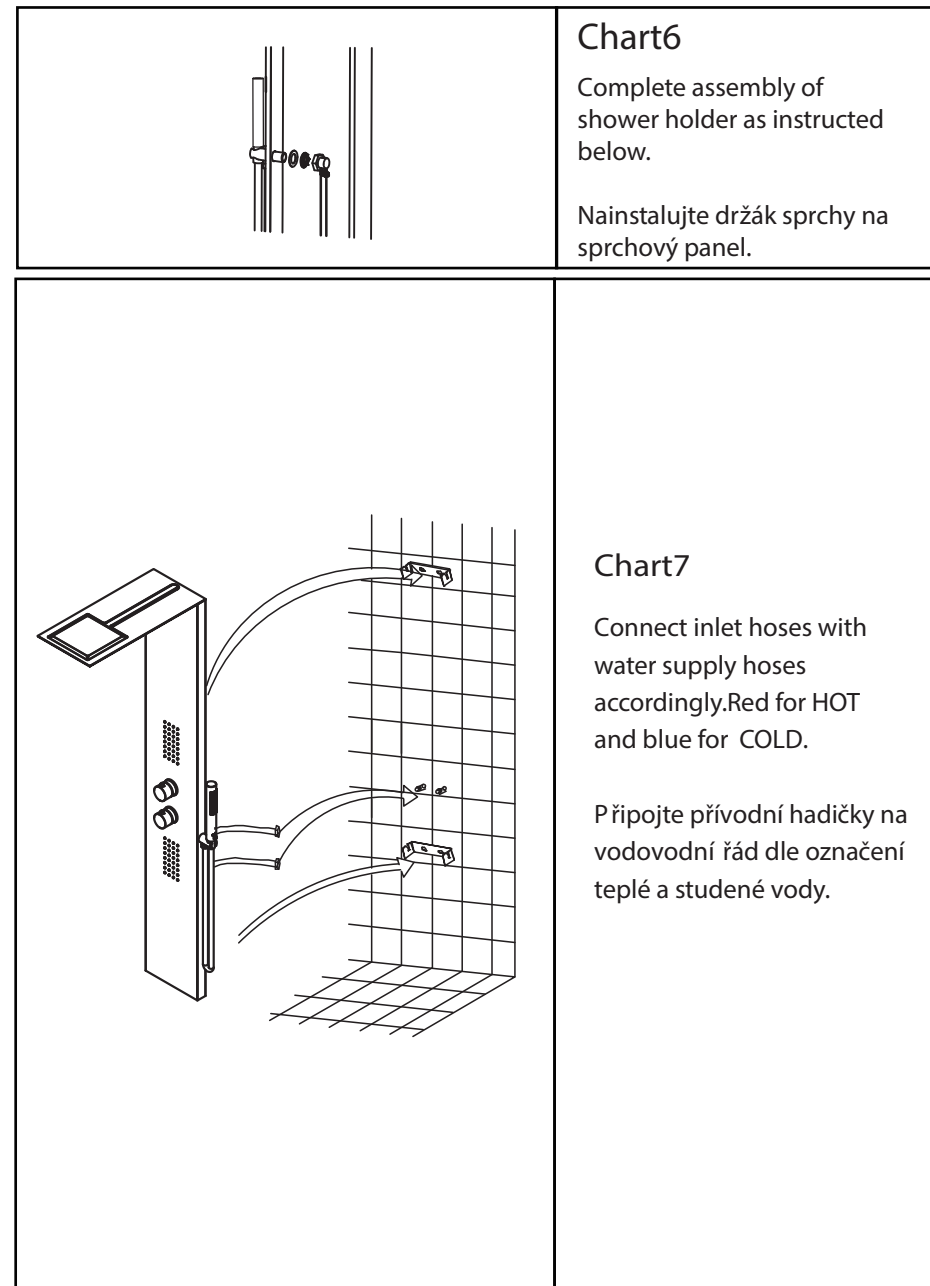
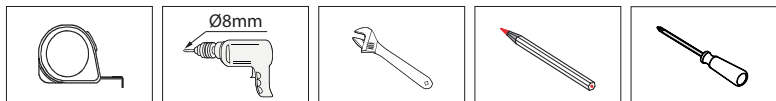

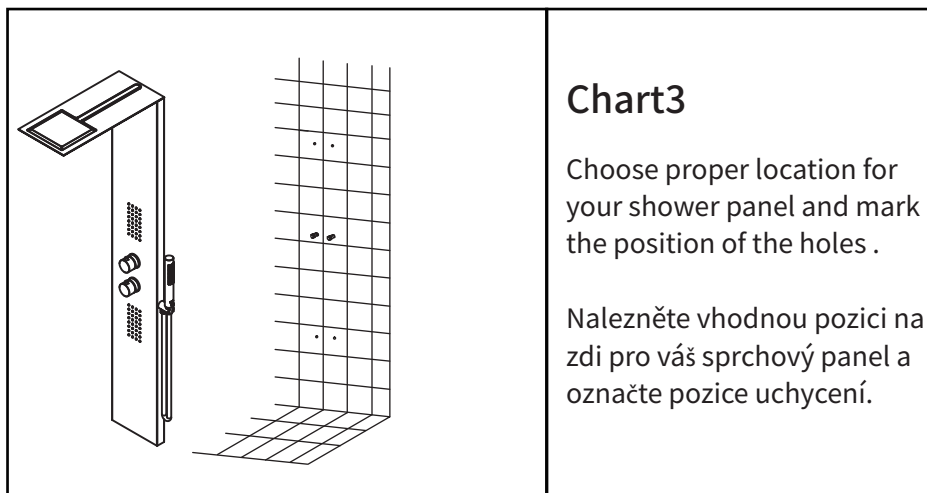

Chart3

Choose proper location for your shower panel and mark the position of the holes .

Nalezněte vhodnou pozici na zdi pro váš sprchový panel a označte pozice uchycení.

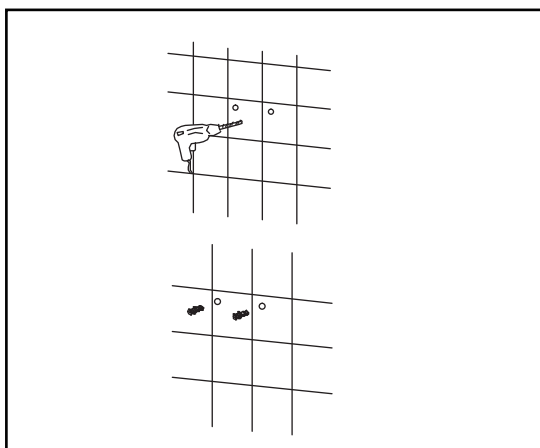

Chart4

Drill the holes in the wall. Insert the wall plugs into the holes. Fix the two wall mounting brackets with self-tapping screws.

Vyvrtejte otvory do stěny a vložte do nich hmoždinky.

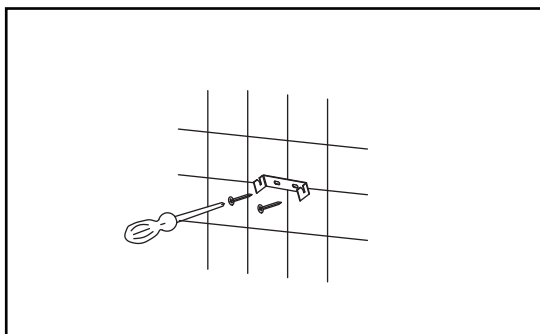
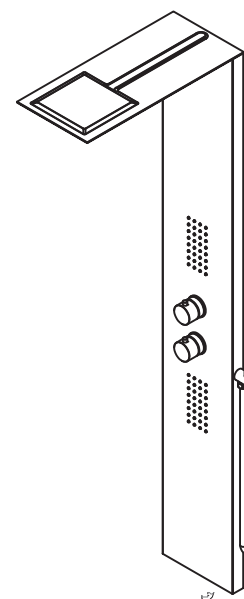













Chart5

Tighten the screws into the wall for wall mounting brackets.

Pomocí šroubů uchyťte pevně 2 držáky panelu.

03/ SPARE PART LIST



| | | | |
|--------|---|--------|---|
| X(1PC) |  | X(2PC) |  |
| X(1PC) |  | X(2PC) |  |
| X(1PC) |  | X(2PC) |  |
| X(1PC) |  | X(8PC) |  |
| X(1PC) |  | X(8PC) |  |
| X(1PC) |  | X(2PC) |  |

04/ DIMENSIONS

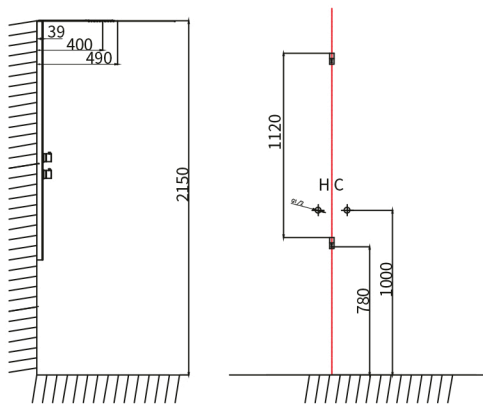
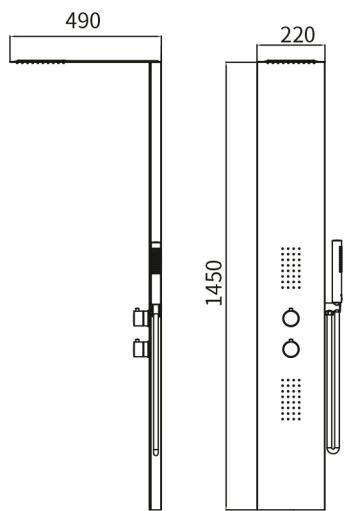

Unit:mm

05/ INSTALLATION

| | |
|--|--|
| | <p>Chart1</p> <p>Flush the water supply lines thoroughly to drain debris and impurities. Shut off the water before installation.</p> <p>Propláchněte přívodní trubky, aby se vyplavily možné nečistoty.</p> |
|--|--|

| | |
|--|--|
| | <p>Chart2</p> <p>Connect shower hose to the shower holder and hand shower. Don't forget to put rubber washers inside both connection nuts.</p> <p>Propojte sprchovou hlavici s držákem sprchy pomocí přiložené hadice. Nezapomeňte vložit do spojů ploché gumové těsnění.</p> |
|--|--|