

MODULAR SHOWER

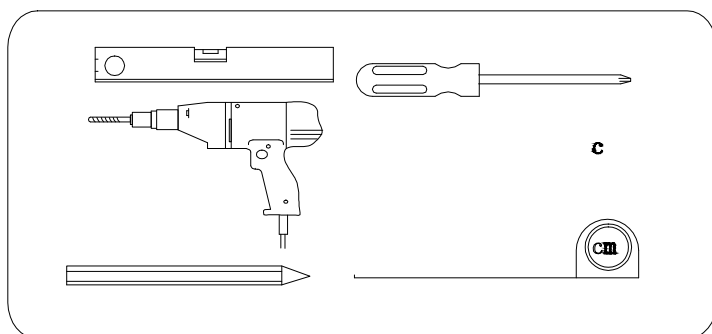

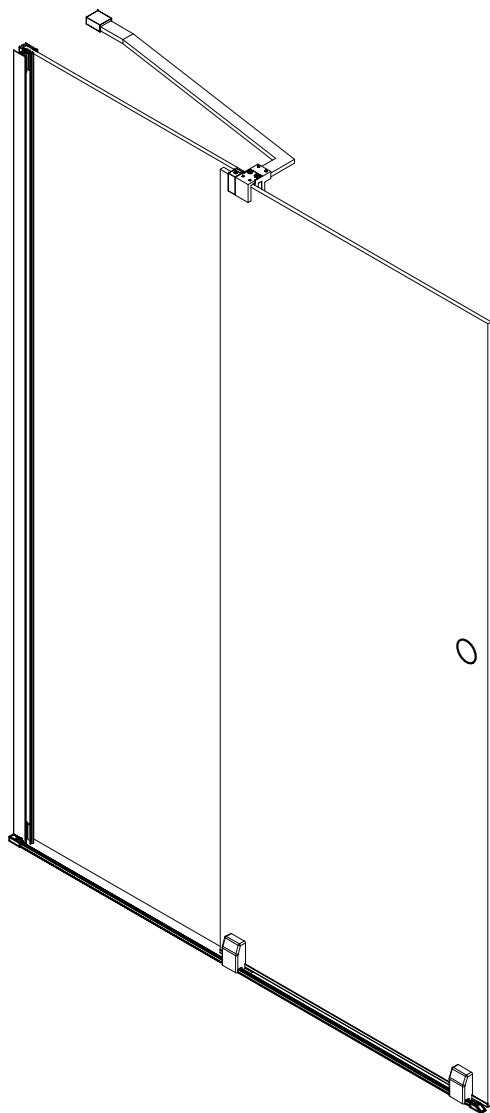













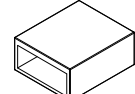
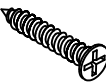

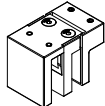
MS5-100/120/140/160

MS5-100B/120B/140B/160B



polysan 



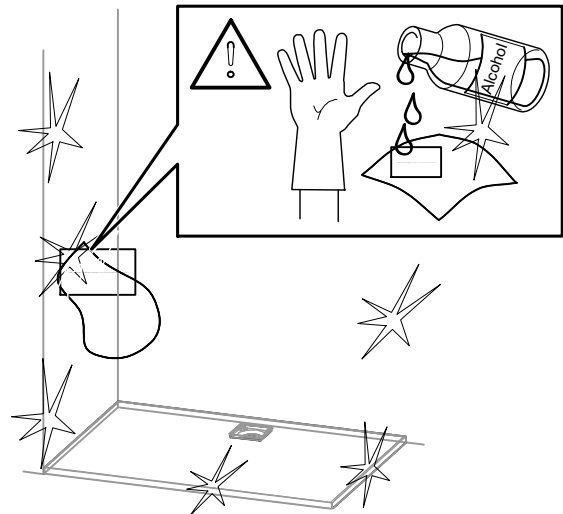
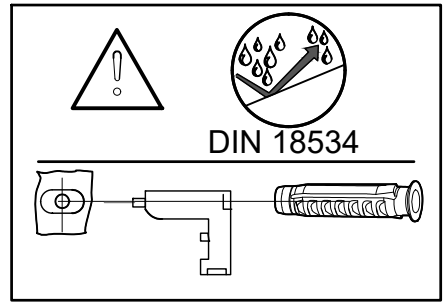

Polysan s.r.o.
Nesměřice 52
285 22 Zruč nad Sázavou
Czech Republic
www.polysan.cz

-  $\phi 8 \times 40 \text{mm}$ 5X
-  $ST5 \times 40 \text{mm}$ 3X
-  $ST4 \times 20 \text{mm}$ 2X
-  $2.5/4 \text{mm}$ 2X
-  3X
-  1X
-  1X
-  1X
-  $ST5 \times 50 \text{mm}$ 2X
-  1X
-  1X
-  1X
-  2X
-  2X
-  1X
-  1X
-  1X
-  1X
-  $\phi 6 \times 30 \text{mm}$ 2x
-  2x
- $1 \times 6 \times 50 \text{mm}$
- $2 \times 6 \times 50 \text{mm}$
- $3 \times 6 \times 50 \text{mm}$

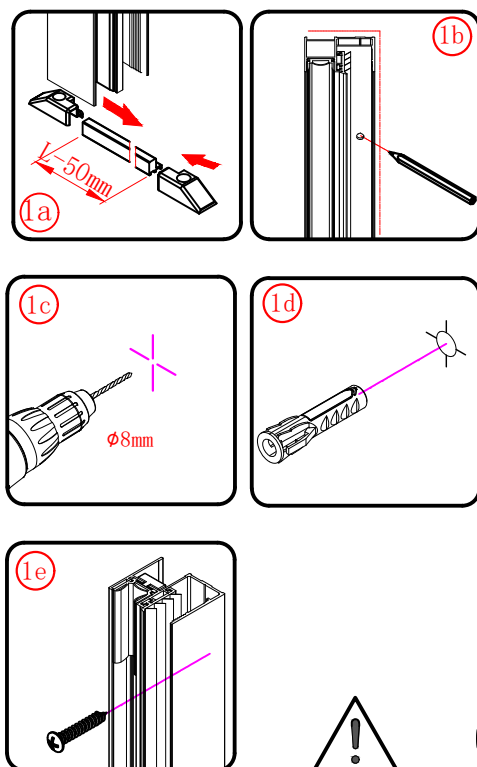
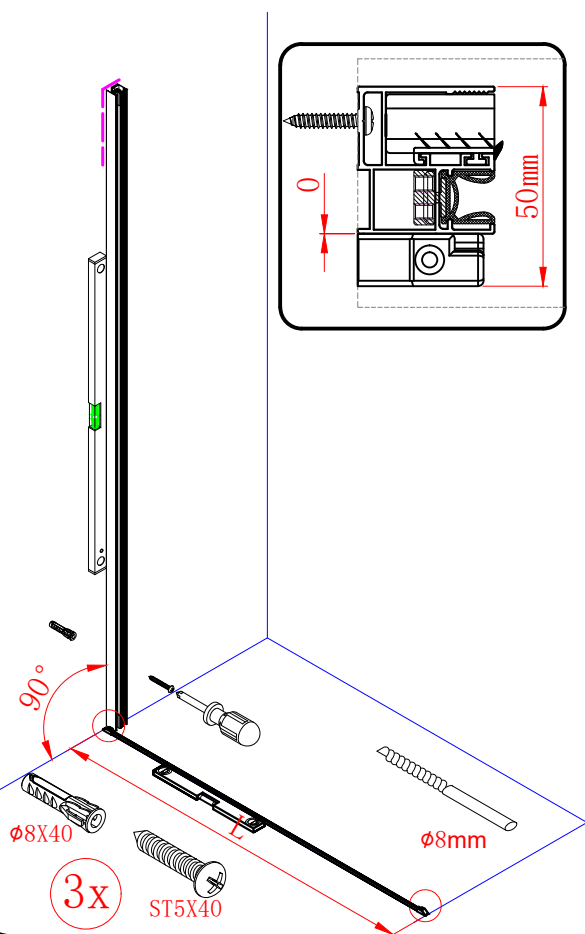

1

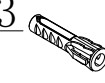

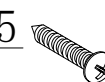
- 1 
- 2 
- 3 
- 4 
- 5 

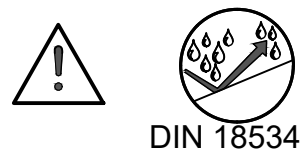

2

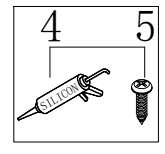
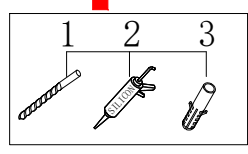
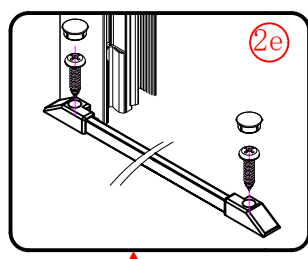
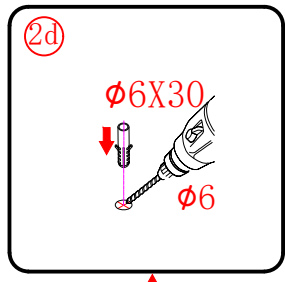
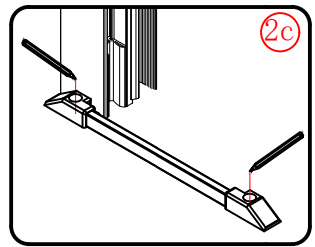
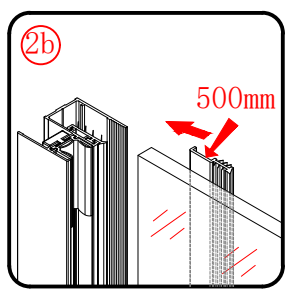
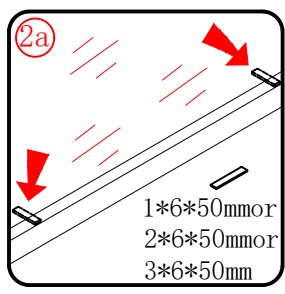
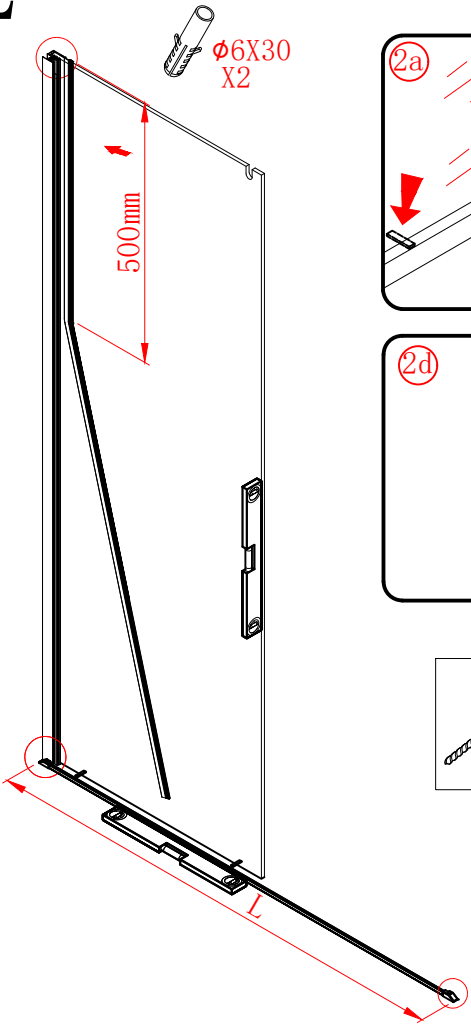

DIN 18534

3

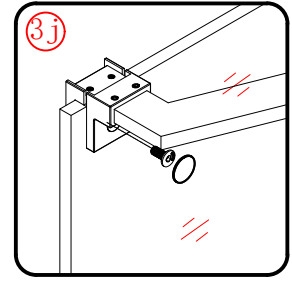
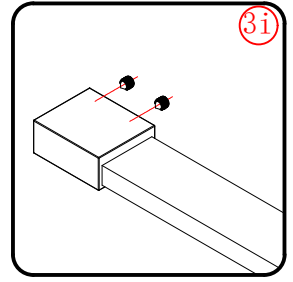
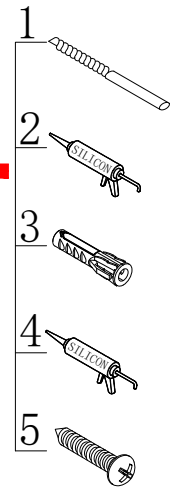
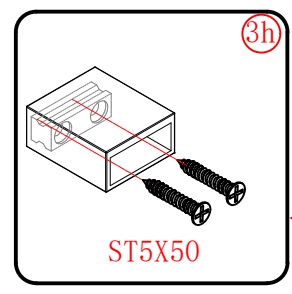
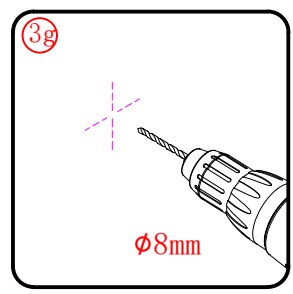
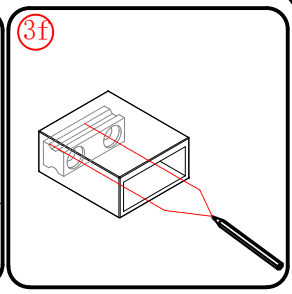
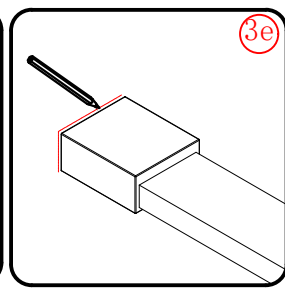
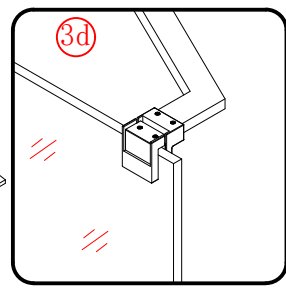
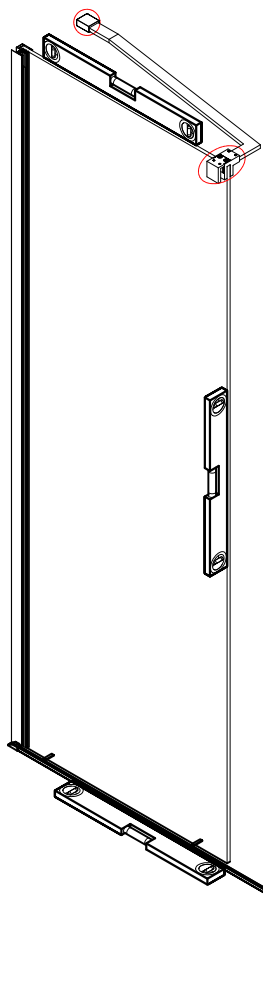
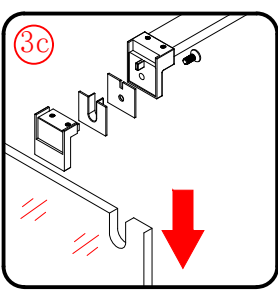
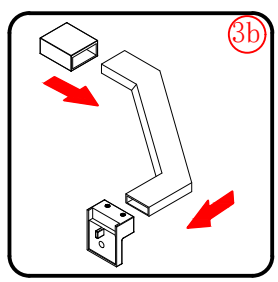
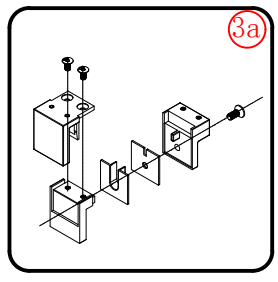

DIN 18534

4

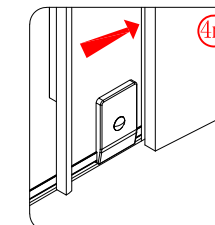
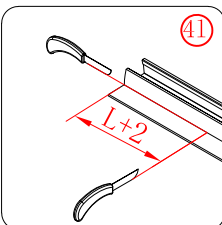
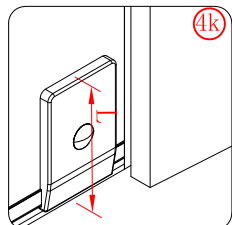
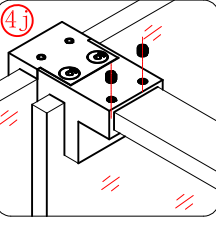
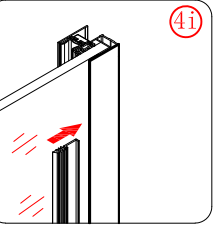
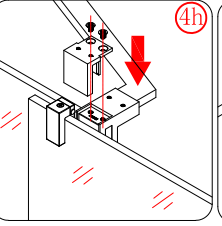
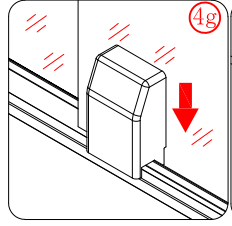
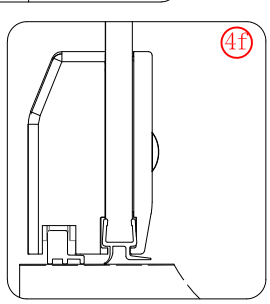
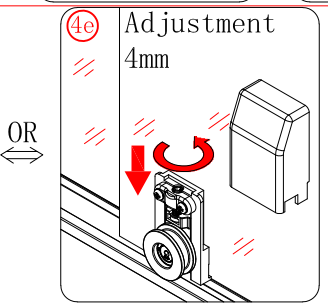
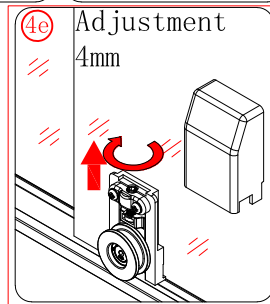
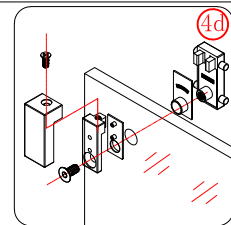
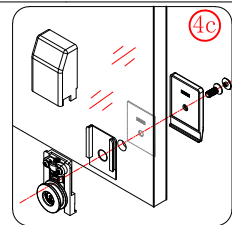
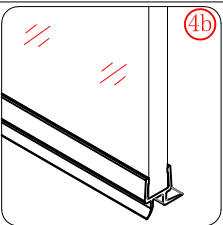
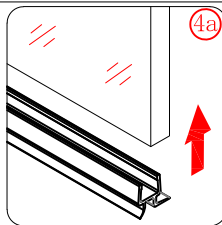
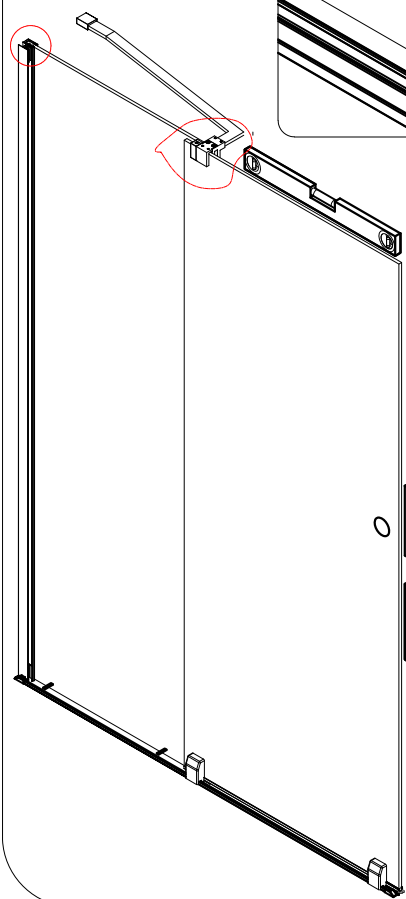

5

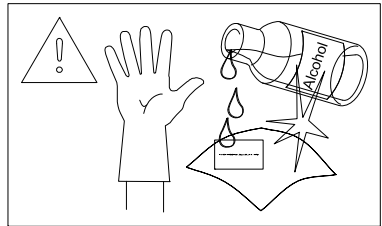
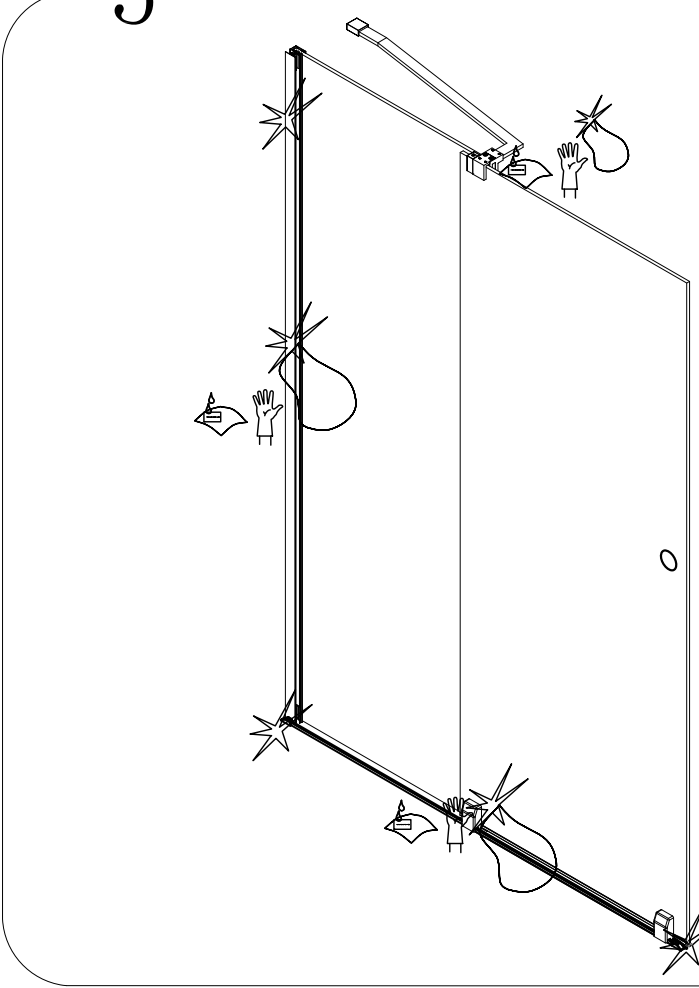

3

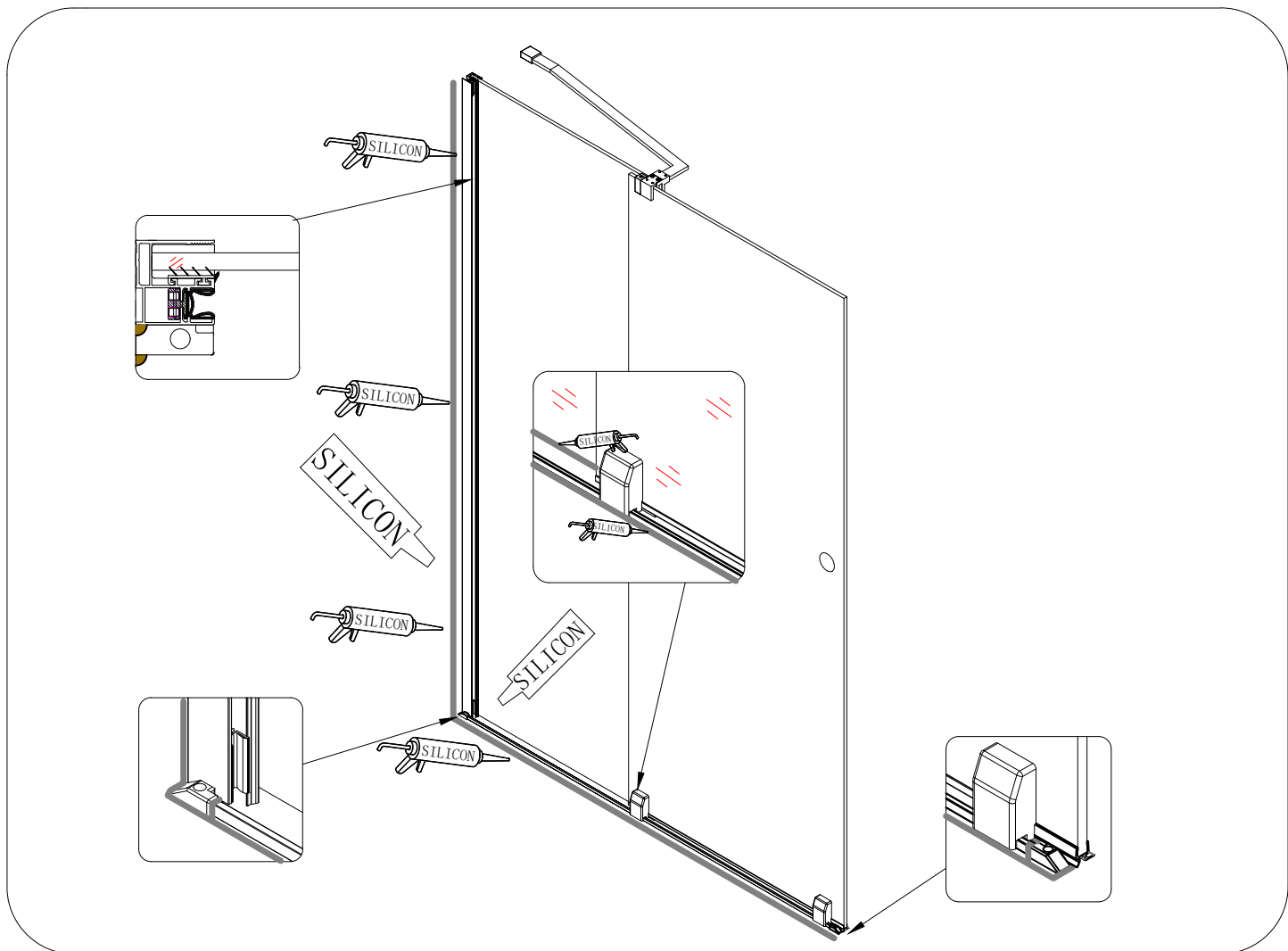
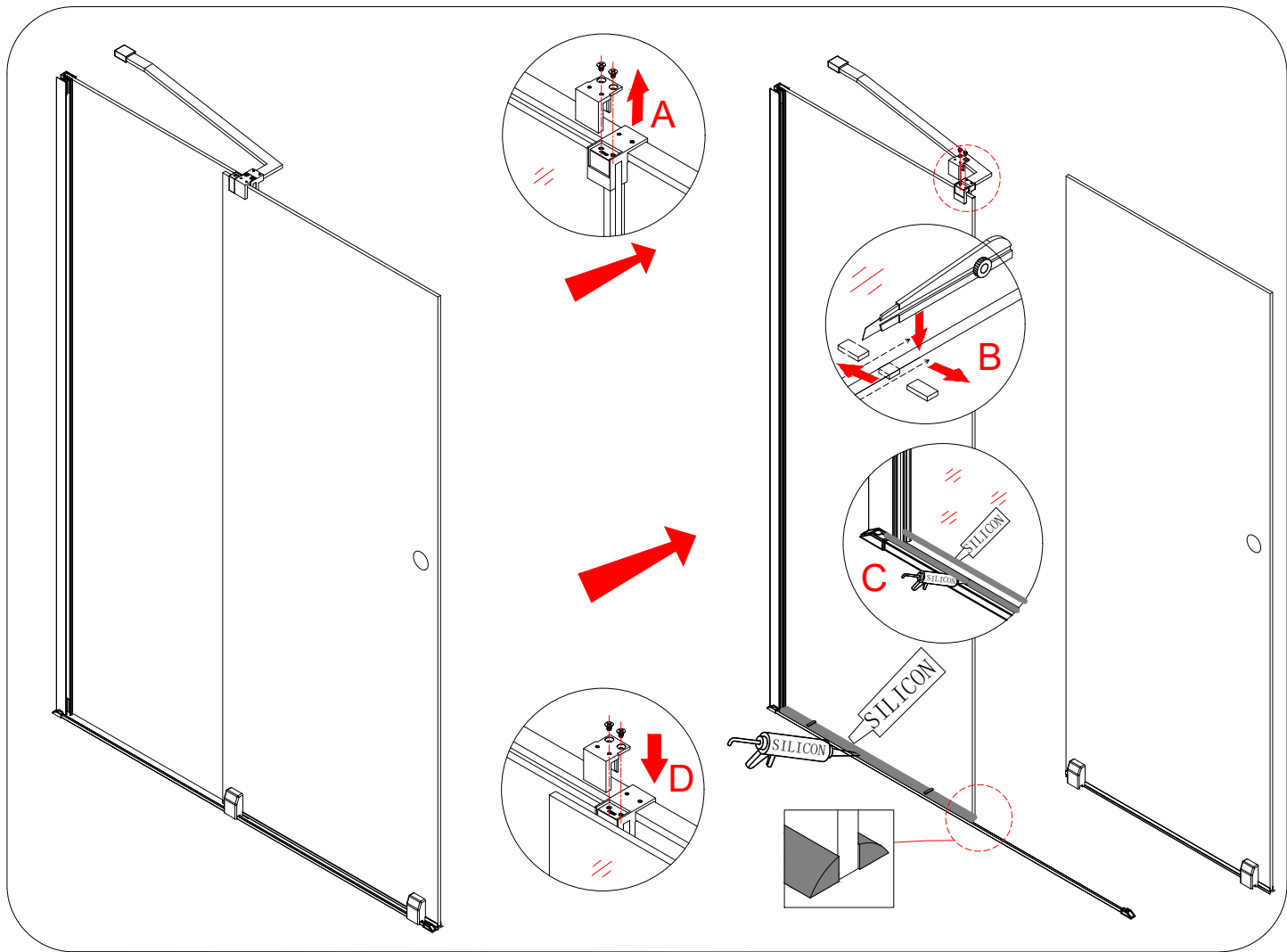



Polysan s.r.o.
Nesměřice 52
285 22 Zruč nad Sázavou
Czech Republic
www.polysan.net

EN 14428

Glass shower enclosure
cleaning efficiency: conforming
impact resistance: conforming
operating life: conforming

Skleněné sprchové zástěny
schopnost čištění: vyhovuje
odolnost proti nárazu: vyhovuje
životnost: vyhovuje